

MODEL 410
and
MODEL 410C

MICRO-MICROAMMETER

KEITHLEY INSTRUMENTS, INC.

CLEVELAND, OHIO

CONTENTS

| | SECTION |
|--|---------|
| INTRODUCTION..... | I |
| DESCRIPTION..... | II |
| Current ranges | |
| Input Impedance | |
| Input Connectors | |
| Input Switch | |
| Grid Current | |
| Zero Drift | |
| Zero Control | |
| Recorder Output | |
| Response Speed | |
| Amplifier Noise | |
| Circuit Description | |
| Calibration | |
| OPERATION..... | III |
| Input Connections | |
| Input Connections Using Direct Leads | |
| Grid Current | |
| Recording | |
| Speed of Response | |
| MAINTENANCE..... | IV |
| Maintenance Adjustments | |
| Insulation | |
| Connector Caps | |
| SPECIAL INSTRUCTIONS FOR THE MODEL 410C..... | V |

SECTION I INTRODUCTION

Model 410

The Keithley Model 410 Micro-microammeter is a line operated vacuum tube electrometer designed and constructed especially for measuring small currents. Full scale ranges are from 10^{-3} to 3×10^{-13} ampere.

The features include full-scale voltage drop at the input of less than five millivolts, zero drift of less than 2% of full scale in eight hours, good accuracy and calibration stability, and simplicity of operation. It also has an output which will drive a 0-1 or 0-5 milliamperere recorder as well as the numerous potentiometer - rebalance recorders; one output terminal is at ground, making it convenient to connect cathode ray oscilloscopes or pen-driving amplifiers, similar to the Brush and Sanborn equipment.

The major panel controls are the range switch (amperes full-scale) and the zero. Minor controls are the Zero Check, used to short circuit the input and in setting the zero, Meter Polarity for providing up-scale readings for currents flowing in either direction, and an ON-OFF power switch. The meter dial is illuminated, and these bulbs serve as the pilot light.

Model 410C

The Keithley Model 410C is identical to the Model 410, except that the panel meter is provided with contacts which can be set to close at any predetermined meter pointer deflection. The delicate contacts of the meter operate a relay in the 410C, and the relay contacts (SPDT) are available for external switching functions through an AN connector on the rear of the chassis.

Response Speed, both models

The 410 and 410C are shipped with capacitors shunting the range resistors on the 10^{-3} through 10^{-12} ampere ranges. The capacitors damp the response, limiting the amplification of spurious disturbances, and preventing overshoot and ringing when a square pulse of current is applied and input cable capacitance is as much as 5000 micro-microfarads. Such damping is usually preferred when long input cables are used, as with remote ion chambers. When maximum speed is desired, as in some production tests, and very short input cables are being used, the capacitors may simply be removed from the range switch. See details on page II-2.

SECTION II DESCRIPTION

Twenty overlapping current ranges, from 10×10^{-4} ampere to 3×10^{-13} ampere are selected by the Amperes Full Scale switch, located left of the Meter. The accuracy of the ranges from 10×10^{-4} through 3×10^{-7} is within 2%, 10×10^{-9} through 3×10^{-13} is within 4%.

Input Impedance is controlled by negative feedback from the output so that the voltage drop across the input terminals is less than 5 millivolts for full-scale meter deflection. This is based on proper zero setting; if the meter needle is not set at zero, with zero input current, about 3 millivolts constant potential per percent of full scale are added to the five millivolts.

The Input Connector is located on the back face of the chassis. It is a UHF connector with teflon insulation, and accepts a standard teflon insulated mating plug. The plug and lead wires or cable should be extremely well insulated to prevent the leakage of the small currents. A cap is provided for keeping dirt out when the instrument is stored.

Input Switch Labelled ZERO CHECK is located to the left of the Range Switch. When depressed, it effectively shorts the input to remove spurious charges, and provides the zero input current reference for zeroing the meter with the Zero Control.

Grid Current is less than 5×10^{-14} ampere, and represents the limit of measurement of a vacuum tube electrometer. This is about 15% of full-scale on the most sensitive range.

Zero Drift is less than 2% of full scale in eight hours on all ranges except 3×10^{-13} ampere where it is less than 4% of full scale in eight hours. These drifts include warmup from a cold start. If a two hour warm-up can be provided, the drift will be one half to one fourth of these amounts.

Zero Control- The Zero knob is located to the right of the meter and is used for zeroing the meter with zero input current. Effectively zero input current can be obtained by depressing the Zero Check button. The input must not be short-circuited. This upsets the negative feedback path and makes it impossible to zero the meter.

It is recommended that the meter pointer not be set anywhere but zero on the meter scale with zero input current, because with the feedback used, a dc potential is developed across the input whenever the output and the panel meter are not zero for zero input current. Recorders, of course, can be biased to any part of their scale for zero volts at the Model 410 output.

Output is provided for driving recorders. The amplifier will develop 5 volts for full-scale meter deflection, and 5 milliamperes can be drawn without upsetting the circuits. The OUTPUT connector is at the rear of the chassis. The connection details and suitable output attenuators are discussed in OPERATION, Section III.

Response Speed of the 410 depends upon the current range being used and also upon the capacitance of the external circuitry. On the less sensitive ranges the speed is limited by the amplifier response, which is from dc to approximately 1,000 cps. On the ranges from 3×10^{-8} to 10×10^{-12} amperes the speed has been reduced to about 1.0 second by the addition of capacitors across the range resistors. On the three most sensitive ranges, shunt capacitance across the input limits the response speed. Because of the method of application of the negative feedback, the slowing effects of capacitance from the high input terminal to ground have been greatly reduced, but are still significant. Table I below gives typical response speeds; viz; the time constant of the response to a step function.

TABLE I

TYPICAL RESPONSE SPEEDS (to read 67% of final value)

| Ranges | No significant external capacitance | | with 5000 mmf across the input | |
|---------------------|-------------------------------------|-------------|--------------------------------|-----------|
| | Undamped | Damped | Undamped | Damped |
| 3×10^{-13} | 2.2 seconds | 2.2 seconds | 4 seconds | 4 seconds |
| 1×10^{-12} | 1.0 " | 1.0 " | 2 " | 2 " |
| 1×10^{-11} | 0.15 " | 1.0 " | .5 " | 1.0 " |
| 1×10^{-10} | 0.10 " | 0.5 " | .2 " | 1.0 " |
| 1×10^{-9} | 0.05 " | 0.5 " | .1 " | 1.0 " |
| 1×10^{-8} | 0.01 " | 0.5 " | .05 " | 1.0 " |

If the maximum speed of response is desired, the capacitors shunting the range resistors may be removed; however the increased response to spurious ac signals may interfere with recording, as mentioned in Section I.

Amplifier Noise is principally power frequency, and is 30 millivolts rms max at the output terminals, irrespective of the current range. From the most general point of view, grid current and amplifier zero drift are also background noise; these have already been discussed.

Circuit Description

The circuit diagram DR 10867-C is enclosed at the back. The amplifier consists of two 5886 electrometer tubes operated as a long-tail pair, with a substantial amount of in-phase rejection. Further in-phase rejection is obtained by supplying V1 and V2 screens from V3 and V4. A triode connected 6CM6 is used as the cathode follower output stage.

Negative feedback from the output (directly, or through a low impedance divider) is accomplished through the shunt resistor to the grid of the input electrometer tube. It is this feedback which keeps the input voltage drop low.

The open loop voltage gain of the amplifier, measured from the first stage grid to the feedback connection which would normally be connected to the low impedance end of the shunt resistor, is about 2500 on the less sensitive ranges, alternates between 1500 and 500 on the middle ranges, and is 150 on the 3×10^{-13} ampere range. This assures a low input drop.

To insure low drift, the feedback-voltage (the voltage drop across the high resistance range resistors) is made large and alternates between 1.0 volt and 3.0 volts for most of the ranges. On the 10×10^{-8} ampere range and those less sensitive it is 5.0 volts, while on the 3×10^{-13} ampere range (the instrument's most sensitive) it is 0.3 volt. The alternation of the feedback voltage is used to economize on the very expensive high megohm resistors, so that only one is used for every decade of measured current. Table II, below, gives the value of E_F and R_S for each current range.

TABLE II

| Range Amperes Full Scale | E_F volts | R_S | Resistor Accuracy % |
|-----------------------------|-------------|------------------|------------------------|
| 10×10^{-4} | 5 | 5K | 0.1 |
| 3×10^{-4} | 5 | 16.67K | 1 |
| 10×10^{-5} | 5 | 50K | 1 |
| 3×10^{-5} | 5 | 166.7K | 1 |
| 10×10^{-6} | 5 | 500K | 1 |
| 3×10^{-6} | 5 | 1.667 Meg | 1 |
| 10×10^{-7} | 5 | 5 Meg | 1 |
| 3×10^{-7} | 5 | 16.67 Meg | 1 |
| 10×10^{-8} | 5 | 50 Meg | 1 |
| 3×10^{-8} | 3 | 10 ⁸ | 1 |
| 10×10^{-9} | 1 | 10 ⁸ | 1 |
| 3×10^{-9} | 3 | 10 ⁹ | 3 |
| 10×10^{-10} | 1 | 10 ⁹ | 3 |
| 3×10^{-10} | 3 | 10 ¹⁰ | 3 |
| 10×10^{-11} | 1 | 10 ¹⁰ | 3 |
| 3×10^{-11} | 3 | 10 ¹¹ | 3 |
| 10×10^{-12} | 1 | 10 ¹¹ | 3 |
| 3×10^{-12} | 3 | 10 ¹² | 3 |
| 10×10^{-13} | 1 | 10 ¹² | 3 |
| 3×10^{-13} | 0.3 | 10 ¹² | 3 |

The power supply is regulated by a Sola transformer. Half-wave selenium rectifiers supply the B+ and B- potentials. The filtering is conventional.

Calibration is determined by the value of the high resistance range resistors and the value of the feedback resistors. From 10^{-3} to 10^{-8} amperes, the overall accuracy is better than 2%. From 3×10^{-9} to 3×10^{-13} amperes, the accuracy is better than 4%.

The meter is connected between the output terminal and ground. When the range resistor is shorted in zeroing the instrument, the meter measures the voltage existing between the input terminal and the output terminal (which are connected together when the shorting button is pressed) and ground.

The balancing of the amplifier, with the Zero control, is done in the filament circuit of V2. This is a convenient low-impedance point and does not disturb the electrode potentials of the low grid current electrometer tube.

SECTION III OPERATION

Simplicity of operation is an outstanding characteristic of the Model 410. First connect the input to a current source, and the output to a recorder or external indicator, if desired.

Then: a) Plug the power cord into a 110 volt 60 cps outlet. Note that because a Sola resonant regulating transformer is used, the power frequency, as well as voltage, must be the proper value.

b) Turn the amperes Full Scale to the 10×10^{-4} position.

c) Turn the power switch to ON.

d) After a few minutes warmup, set the panel meter to zero with the ZERO control.

e) Advance the instrument's sensitivity with the range switch, until a usable deflection is obtained on the panel meter. The current is read directly. Attention should be paid to the METER polarity switch, so that an up-scale deflection is obtained.

f) Periodically check the zero setting by operating the ZERO CHECK switch and rezeroing the meter if necessary.

Input, using cabling

The current source should be connected to the input connector with the high impedance side of the current source associated with central conductor of the connector. The lead-in cable should be polyethylene, polystyrene, or teflon insulated coaxial cable, and the connector should have teflon insulation. Amphenol type 83-756 or equivalent is recommended. During preparation of cable and connectors, it is essential that all high impedance surfaces be kept scrupulously clean to avoid leakage. With graphite coated cable, it is necessary to avoid tracking graphite onto the high impedance surfaces of the cut end of the insulation and the teflon surface of the connector. Movement of the cable during measurement should be avoided since this will cause spurious needle movements, because of capacitance changes and generation of static charges.

GRID CURRENT in the Model 410 is less than 5×10^{-14} ampere - usually about 2×10^{-14} ampere. It can be read directly on the 3×10^{-13} ampere range after carefully shielding the high impedance input conductor such as by screwing the connector cap on.

The grid current can be subtracted algebraically from the total current read on the meter to give the correct current in the circuit being measured - on the most sensitive ranges.

RECORDING: The Model 410 is provided with a connector on the rear of the chassis for recording. The output for full-scale meter deflection is +5 volts. The maximum current that may be drawn from the output terminals is 5 milliamperes. This output is suitable for driving one and five milliamperere recorders as well as recorders employing an amplifier. Cinch-Jones S-202-B is the chassis connector, P-202-CCT is the mating plug. Terminal #1 is ground.

Table III gives resistance to be used in series with one and five milliampere recording milliammeters, to make the recorder full-scale deflection equal the panel meter full-scale deflection.

TABLE III

| Recorder | Series Resistance |
|----------|-------------------|
| 1 m.a. | 3.3 to 3.7K |
| 5 m.a. | 920 to 940 |

The exact series resistance varies from recorder to recorder, and a portion of the series resistance should be adjustable so that the recorder may be calibrated exactly against the panel meter.

A suitable voltage divider for more sensitive recorders can easily be made, keeping in mind that 5 volts appear at the output terminals for full-scale deflection of the panel meter, and that a 1000 ohm divider will not draw too much output current and will be sufficiently low impedance to connect to amplifier inputs.

The Speed of Response, or the time constant of an input transducer and micro-microammeter, depends upon the speed of response of the circuitry of the instrument and also upon the capacitance of the current source and its connecting cable. Because of the way the negative feedback is applied in the Model 410, the external input capacitance is not nearly as important as in systems using a voltmeter across a shunting resistor, and quite large capacitances can be tolerated without having an impossibly slow response. Thus, a cable run from an ion chamber to the micro-microammeter is permissible.

The internal time constant of the Model 410 depends upon both the frequency response of the amplifier stages and the time constants of the high megohm range resistors and the associated distributed capacitances. These change from range to range on the 410, the speed decreasing as the sensitivity is increased. Table I in Section II, Description, gives quantitative values.

±216 Volts. A connector has been mounted on the back face of the chassis to provide ±216 volts for polarizing an ion chamber. The potential is derived from 2 0B2 voltage regulator tubes, and is well filtered. The supply can be short circuited without damaging it. The chassis connector is Cinch-Jones S101, and P101 is the mating plug.

SECTION IV MAINTENANCE

The Keithley Model 410 Micro-microammeter has been designed to give long, trouble-free service. High quality components have been used throughout, and the circuits are stabilized by a substantial amount of negative feedback.

DR 10867-C, at the back, is the detailed circuit schematic diagram of the Model 410. The circuit operation was discussed in Section II, Description.

Maintenance Adjustments

One maintenance control is provided. It is accessible from the top of the chassis, and is located behind the meter.

R138, METER CALIBRATION, is in series with the Meter. To recalibrate, use the 10×10^{-4} range and, with 7×10^{-4} ampere through the input circuit, adjust R138 so the meter reads exactly 7.0. Since the shunt resistor on this range is accurate to 0.1% of its nominal value the overall accuracy can be adjusted to about 1% of full scale. On the 3×10^{-4} to 10×10^{-9} ampere range the range resistors are accurate to 1% and, providing the calibration was accurately done on the 10×10^{-4} range, the overall accuracy will be 2%. From 3×10^{-9} to 3×10^{-13} amperes the range resistors are accurate to 3% and the overall accuracy will be 4%.

Vacuum Tubes V1 and V2 are the two electrometer tubes, and are located in an aluminum can which plugs onto the top of the chassis near the input terminals. The tubes have been selected, matched and labelled; V1 is Keithley part EV5886-5 and V2 is EV5886-6. The difference between the two is that EV5886-6 does not have to have low grid current. It is recommended that the complete Input Tube assembly Model 4102, be kept for replacement purposes.

The other tubes are standard receiving tubes and need no special selection to assure satisfactory performance of the Model 410.

INSULATION: All insulation for the high impedance conductors is made of teflon, as are the contact insulators on the range switch. This should give satisfactory service in all humidities. Occasionally, the high impedance insulators should be inspected to insure that they are free from dirt and dust.

CONNECTOR CAP: The cap for the input connector should be kept in place whenever the connector is not being used. In storage and in transport, it keeps the insulation from accumulating dust and dirt. Before screwing the cap back onto the connector, be certain that it is clean, so the insulation will not be contaminated.

SECTION V SPECIAL INSTRUCTIONS FOR THE MODEL 410C

DR 11165-C is the circuit schematic diagram of the Model 410C. It differs from the 410 in providing the meter contacts, and the relay which is controlled by them.

The meter-relay is manufactured by Assembly Products, Inc., of Chesterland, Ohio, Model 461-C. Its contacts will close when the black meter pointer coincides with the red index pointer. The index can be set easily to any point on the meter scale by rotating the black knob on the front of the meter.

To obtain reliable contacting of the meter, the contacts are locked together electrically. Unlocking can be accomplished by operating the RESET button on the panel, or by a remote switch.

To complete the locking path, it is necessary that contacts A and B of the AN connector be connected. This can be done within the mating male plug, if resetting is to be done only with the panel button, or leads can be run to a remote reset relay or switch.

The one AN connector, it will be seen on the schematic diagram, is used for the resetting circuit, control relay contacts, and the output to a recorder.

The relay contacts are rated 5 amperes at 110 volts AC, or 24 volts DC.

PERFORMANCE REPORT

MODEL 410

This report is intended to supply data on performance in addition to or outside of our published specifications. Measurements are made on stock instruments and are to serve as a guide rather than a limitation or guarantee of performance of any particular instrument.

Four tests are included:

- 1) Overload characteristics
- 2) Linearity
- 3) Response Speed
- 4) Drift

MODEL 410

Figure 1 shows the performance of the output signal with several full scales overload. Curves are shown for no load and for 1K load, and the input signals used were both positive and negative.

Figure 2 shows the linearity between negative full scale and positive full scale. As may be seen, it is so good it is hard to measure. This is the amplifier output only and has nothing to do with meter linearity.

Please note that the range used employs one volt feedback. The linearity may be expected to be 3 times as good on ranges using 3 volts, 5 times as good on ranges using 5 volts and only .3 times as good on the most sensitive range.

Chart 3 is a listing of response speeds for all decade ranges and the most sensitive range with small input capacity and with 5000 mmf input capacity, for the standard unit and for the standard unit with range switch capacitors removed.

On some ranges, overshoot is encountered. For these, the overshoot in percent of full scale is recorded.

The times given are to reach 90% of final value. Conversion to standard electrical "time constant" is made by dividing by 2.3. For example, the standard unit on the 10×10^{-12} range has a 90% response time of 2.3 seconds. This means a "time constant" of 1 second.

Figure 4 shows the 3-day drift record of a "typical" unit. Remember that,

on any ranges, the drift record will be $\frac{e}{.3}$ times as good as the record

shown (on the 3×10^{-13} range, the feedback voltage is .3 volts). Thus, on any range above 10×10^{-8} ($e_f = 5v$) the scale of Fig. 4 could be compressed 16.7 times.

PERFORMANCE REPORT
MODEL 411

Because the same amplifier is used in the 411, the characteristics are quite similar. The following changes apply, however:

1. Overload: Since e_f is always full output, the linearity is as shown in Fig. 1 for no load except that 1 full scale for the 410 is $\frac{1}{2}$ full scale for the 411 and 1% for 410 is $\frac{1}{2}$ % for 411. The dashed curve is approximately correct except that in the 411 it is for 2K (5 ma) load.
2. Linearity: About 5 times as good as Fig. 2.
3. Chart 5 shows the range-by-range response speeds for the Model 411.
4. Drift record (Fig. 4) should have the scale compressed 33 times.

EUGENE DIETZEN CO.
MADE IN U.S.A.

DIETZEN DRAFTER
MILLIMETER

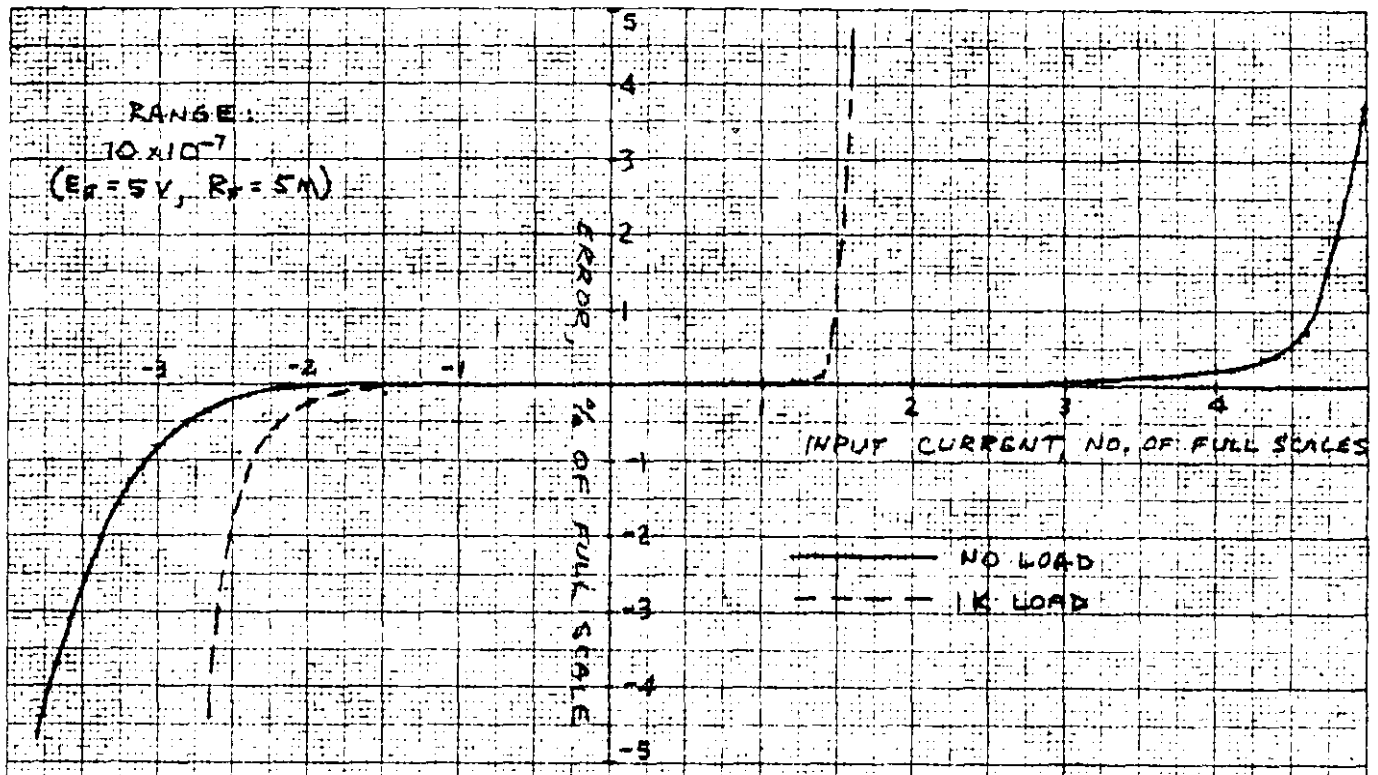

MODEL 410 OVERLOAD CHARACTERISTICS
FIG. 1

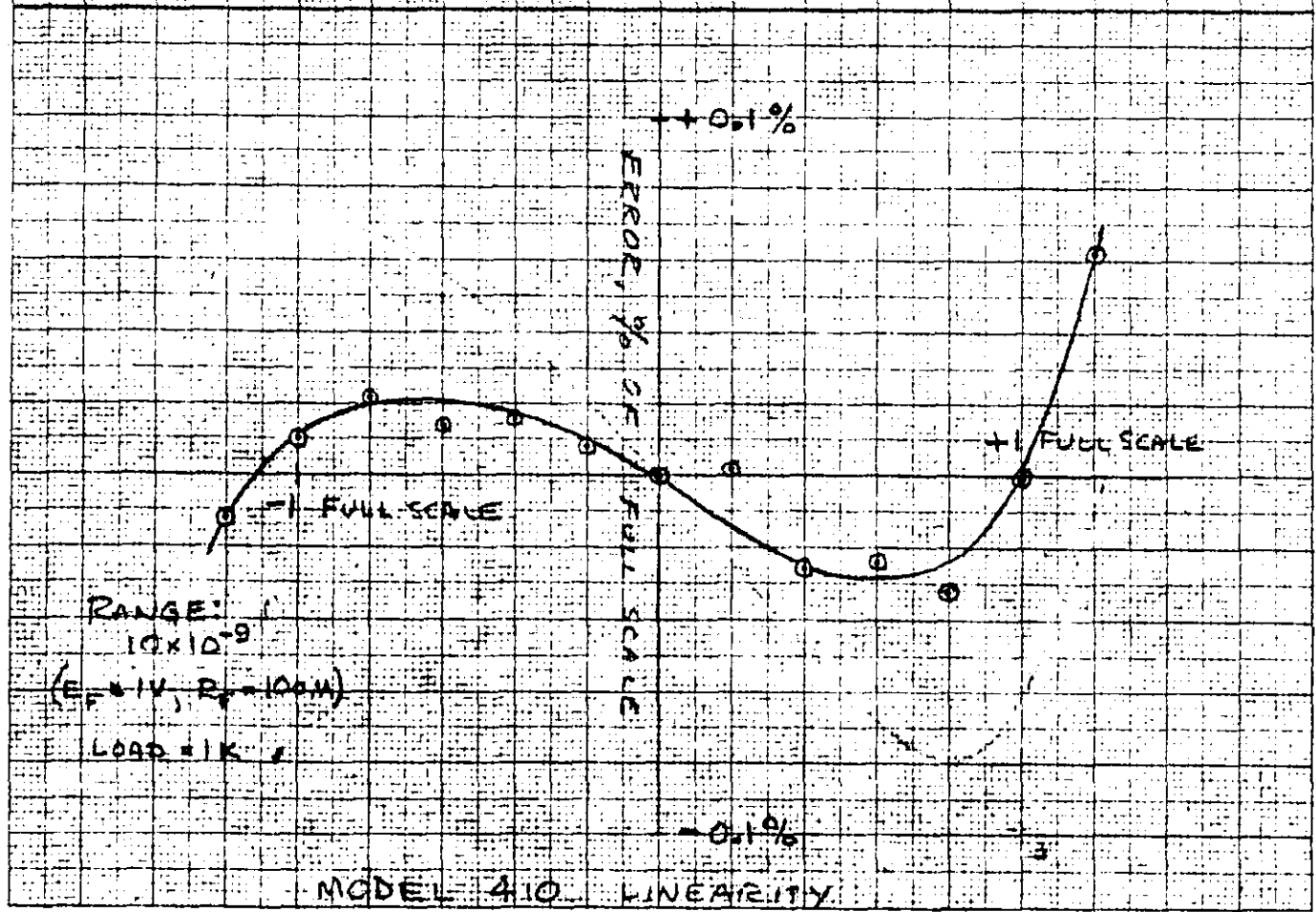

MODEL 410 LINEARITY

FIG. 2

Chart 3 - 410 Response Speed

Time to reach 90% of final value

| Range | Standard | | Range Switch Capacitors OFF | | e. |
|----------------------|----------------------------------|----------------------------|-----------------------------|----------------------------|----|
| | Small (20 mmf) Input capacity | 5000 mmf Input capacity | Small Input capacity | 5000 mmf Input capacity | |
| 3×10^{-13} | 10 seconds | 60 seconds | 10 seconds | 60 seconds | 3. |
| 10×10^{-13} | 8 | 20 | 8 | 20 | 1. |
| 10×10^{-12} | 2.3 | 2.6 | .65 | 1.5 | 1. |
| 10×10^{-11} | 1.2 | 1.6 | .07 | .25 (20%) | 1. |
| 10×10^{-10} | 1.1 | 1.4 | .009 (15%) | .06 (60%) | 1. |
| 10×10^{-9} | 1.0 | 1.2 | .0025 (15%) | .018 (70%) | 1. |
| 10×10^{-8} | .0012 | .006 (70%) | .0012 | .006 (70%) | 5. |
| 10×10^{-7} | .0012 | .002 (50%) | .0012 | .002 (50%) | 5. |
| 10×10^{-6} | .0012 | .001 (10%) | .0012 | .001 (10%) | 5. |
| 10×10^{-5} | .0012 | .001 | .0012 | .001 | 5. |
| 10×10^{-4} | .0012 | .001 | .0012 | .001 | 5. |

Notes:

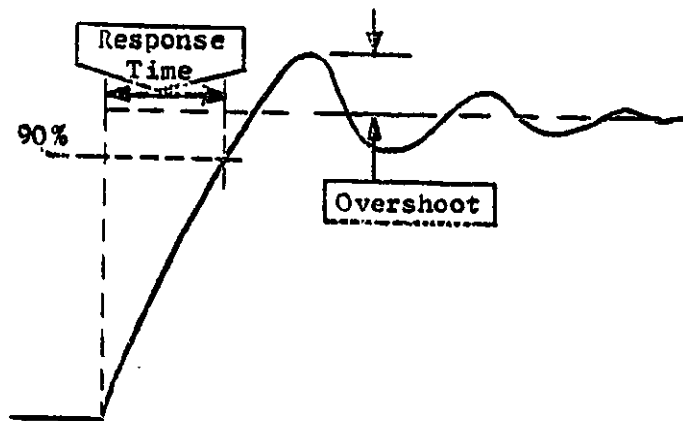

.006 (70%) means 6 ms to reach 90% of step with 70% of step overshoot

.070 means 70 ms to reach 90% of step with no overshoot

Chart 3 - 411 Response Speed

Time to reach 90% of final value

| Range | Standard | | Range Switch Capacitors OFF | | e _r |
|------------------------|----------------------------------|----------------------------|-----------------------------|----------------------------|----------------|
| | Small (20 mmf) Input capacity | 5000 mmf Input capacity | Small Input capacity | 5000 mmf Input capacity | |
| 10 x 10 ⁻¹² | 8 seconds | 13 seconds | 8 seconds | 13 seconds | 10v |
| 10 x 10 ⁻¹¹ | 2.3 | 2.5 | 1.6 | 2.0 | 10v |
| 10 x 10 ⁻¹⁰ | 1.4 | 1.6 | .14 | .13 | 10v |
| 10 x 10 ⁻⁹ | 1.2 | 1.4 | .016 | .025 (40%) | 10v |
| 10 x 10 ⁻⁸ | 1.2 | 1.4 | .003 | .0075 (60%) | 10v |
| 10 x 10 ⁻⁷ | .0012 | .0023 (40%) | .0018 | .0025 (40%) | 10v |
| 10 x 10 ⁻⁶ | .0012 | .001 | .0012 | .001 | |
| 10 x 10 ⁻⁵ | .0012 | .001 | .0012 | .001 | |
| 10 x 10 ⁻⁴ | .0012 | .001 | .0012 | .001 | |

Notes:

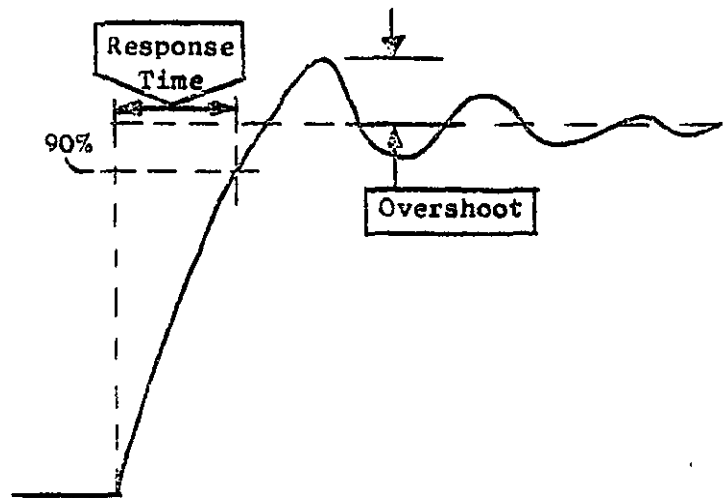

.006 (70%) means 6 ms to reach 90% of step with 70% of step overshoot

.070 means 70 ms to reach 90% of step with no overshoot

GENE ZOEY
MADE IN U.S.A.

DIE GR. PER
6 X 8 PER INCH

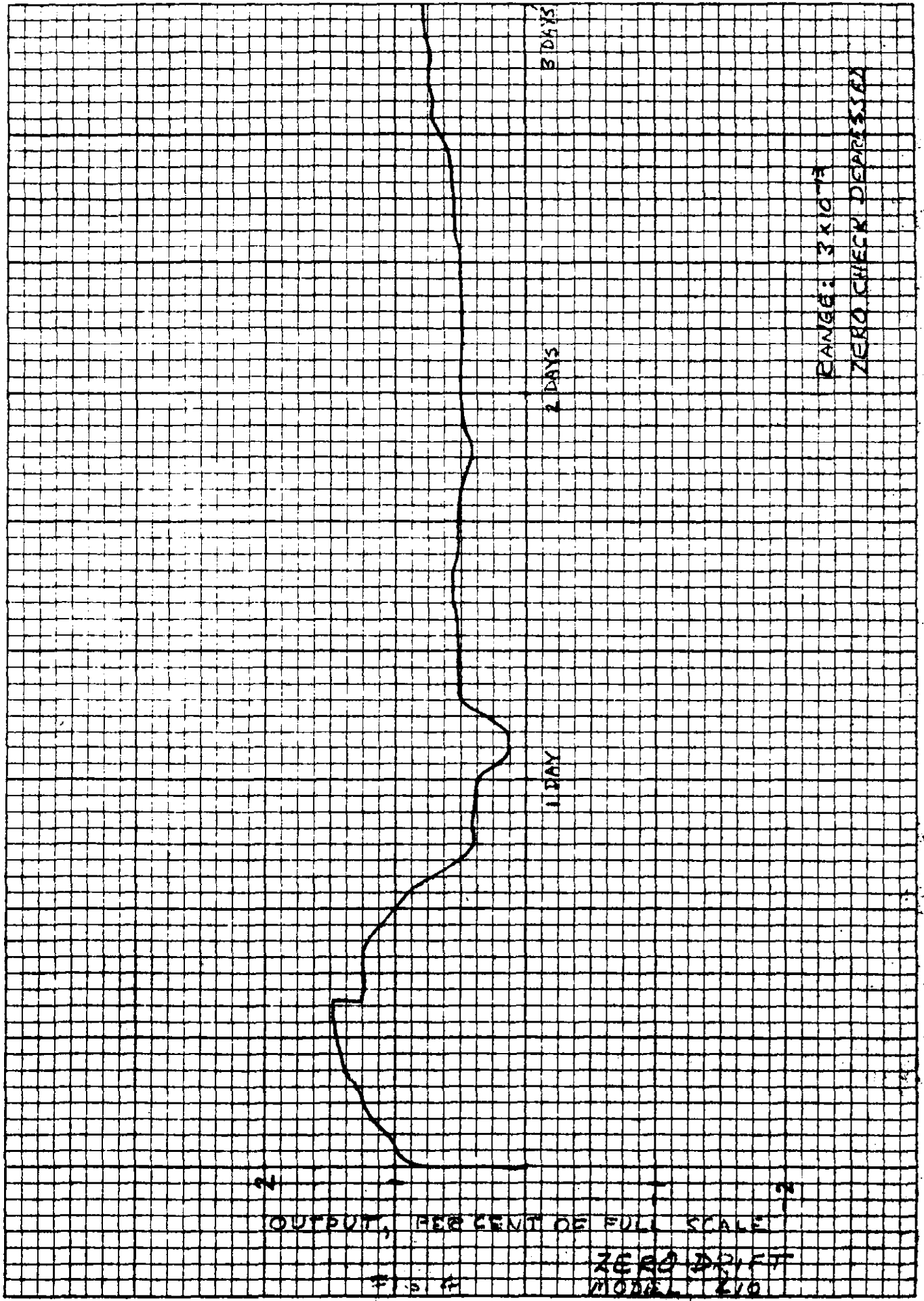

RANGE: 3×10^{-4}
ZERO CHECK DEPRESSOR

OUTPUT, PER CENT OF FULL SCALE

FIG. 4

ZERO DRIFT
MODEL 410

KEITHLEY MODEL 410. TROUBLE SHOOTING PROCEDURE.

FAULT: Will not zero. Refer to Schematic DR 10867-0

PROCEDURE: Use VTVM, DD voltages referred to ground.

A. Check power supply voltages

1. Input can (4102) pin 2; + 130V
2. Supply end of R135 from V5 pin 7; - 140V
3. V5 pin 9; + 150V

If voltages are incorrect, check power supply tubes and components.

- B. The following potentials will depend on the setting of the ZERO control. However, if it is possible to swing the check point through the correct value by adjusting the ZERO control it may be assumed that the stage is working. Proceed until the point is found where the voltage value cannot be obtained. Then check the tube and then the components of that stage.**

4. Input can pin 1 ; + 10V
5. Input can pin 3 ; + 3.8V
6. Input can pin 4 ; + 2.5V
7. Input can pin 5 ; + 10V
8. Input can pin 6 ; + 8V
9. Input can pin 7 ; + 3.8V
10. Input can pin 8 ; + 2.5V
11. Input can pin 9
and 10 ; 0
12. ZERO control,
wiper, + 1V
13. V3 and V4 (6CB6)
pin 1 ; + 10V
14. V3 and V4 pin 2
and 7 ; + 11.5V
15. V3 and V4 pin 6 ; + 47V
16. V3 pin 5 ; + 130V
17. V4 pin 5 ; + 75V
18. V5 (6CM6) pin 1 ; + 130V
19. pin 3 & 6 ; -10V
20. pin 7 ; 0

SPECIFICATION FOR BELL TELEPHONE LABORATORIES MODEL 410-BL PICOAMMETER

1. Ranges:

1 x Full Scale Overlapping Ranges
 $\sqrt{10}$ x Full Scale
 10^{-12} to 10^{-3} Amperes

2. Output:

0 to 1 Volt on 1 x Ranges @ 5 Ma.
0 to .949 Volt on $\sqrt{10}$ x Ranges at the 3x meter indication @ 5 Ma.
Full Scale on the $\sqrt{10}$ x ranges is 1 Volt.

3. Accuracy:

+1% of full scale from 10^{-3} to 10^{-8} amperes at the output; +1.5% at the meter.
+2% of full scale from 10^{-12} to $\sqrt{10} \times 10^{-8}$ amperes at both meter and output.

Zero Suppression is capable of being set within $\pm 0.5\%$ of value with the "Fine Zero Suppress" control and is usable up to 100 full scales.

4. Zero Drift:

+2% of full scale in a 24 hour period after a 30 minute warmup, providing source voltage is not less than 1 volt.

5. Input:

Grid current is less than 5×10^{-14} amperes.

Input voltage drop is less than 5mv.

Effective input resistance is 1.5 ohms at 10^{-3} amperes to 15×10^9 ohms at 10^{-12} amperes.

All inputs - Standard Model 410

REPLACEABLE PARTS LIST - MODEL 410

| Circuit Desig. | Description | Part No. |
|-------------------|---|-------------|
| C101 | Capacitor, polystyrene, 5000 mmf, 100 WV, 25% | C21-5000 |
| C102 | Capacitor, polystyrene, 500 mmf, 100 WV, 25% | C31-500 |
| C102 | Capacitor, polystyrene, 50 mmf, 100 WV, 25% | C31-50 |
| C104 | Capacitor, polystyrene, 5 mmf, 100 WV, 25% | C31-5 |
| C105 | Capacitor, ceramic, 0.02 mfd, 600 WV, GMV | C22-.02 |
| C106 | Capacitor, ceramic, 100 mmf, 600 WV, 10% | C22-100 |
| C107 | Capacitor, ceramic, .001 mfd, 600 WV, 10% | C22-.001 |
| C401 | Capacitor, electrolytic, 40 mfd, 250 WV | C27-40 |
| C402 | Capacitor, electrolytic, 150 mfd, 150 WV | C9 -150 |
| C403 | Same as C401 | |
| C404 | Same as C402 | |
| C405 | Same as C401 | |
| C406 | Capacitor, electrolytic, 20 mfd, 450 WV | C8 -20L |
| C407 | Capacitor, ceramic, 0.02 mfd, 600 WV | C22-.02 |
| C408 | Capacitor, oil filled, 1.0 mfd, 850V AC | |
| FU 1 | Fuse, 1.5 amp type 3AG | FU -8 |
| ME1 | Meter, 0-200 micro-amperes, illuminated dial. Meter bulbs G.B. type 323. <u>PL-1</u> | ME -6 |
| R101 | Resistor, wire wound, 5K, 0.1%, $\frac{1}{2}$ W | R18-16-5K |
| R102 | Resistor, deposited carbon, 16.67K, 1%, 1W | R13-16.67K |
| R103 | Resistor, deposited carbon, 50k, 1%, 1W | R13-50K |
| R104 | Resistor, deposited carbon, 166.7K, 1% 1W | R13-166.7K |
| R105 | Resistor, deposited carbon, 500K, 1%, 1W | R13-500K |
| R106 | Resistor, deposited carbon, 1.667 meg, 1%, 1W | R13-1.667M |
| R107 | Resistor, deposited carbon, 5 meg, 1%, 1W | R13-5M |
| R108 | Resistor, deposited carbon, 16.67 meg, 1%, 1W | R13-16.67M |
| R109 | Resistor, deposited carbon, 50 meg, 1%, 2W | R14-50M |

REPLACEABLE PARTS LIST - MODEL 410

| Circuit Desig. | Description | Part No. |
|-------------------|--|----------------------|
| R110 | Resistor, deposited carbon, 100 meg, 1%, 2W | R14-100M |
| R111 | Resistor, high megohm, 10^9 ohms, 3% | R20-10 ⁹ |
| R112 | Resistor, high megohm, 10^{10} ohms, 3% | R20-10 ¹⁰ |
| R113 | Resistor, high megohm, 10^{11} ohms, 3% | R20-10 ¹¹ |
| R114 | Resistor, high megohm, 10^{12} ohms, 3% | R20-10 ¹² |
| R115 | Resistor, wire wound, 2K, 0.25%, $\frac{1}{4}$ W | R18-15-2K |
| R116 | Same as R115 | |
| R117 | Resistor, wire wound, 700 ohms, 0.25% $\frac{1}{4}$ W | R18-15-700 |
| R118 | Resistor, wire wound, 300 ohms, 0.25%, $\frac{1}{4}$ W | R18-15-300 |
| R119 | Resistor, composition carbon, 22 meg, 10%, $\frac{1}{2}$ W | R1-22M |
| R120 | Resistor, deposited carbon, 10 meg, 1%, 1W | R13-10M |
| R121 | Same as R120 | |
| R122 | Potentiometer, ten turn, 200 ohms, 5% tol. | RP4-200 |
| R123 | Resistor, power 12.5K, 7W, 3% | R7-12.5K |
| R124 | Same as R123 | |
| R125 | Resistor, deposited carbon, 100K, $\frac{1}{3}$ W, 1% | R12-100K |
| R126 | Resistor, wire wound, 150 ohms, $\frac{1}{4}$ W, 1% | R18-6-150 |
| R127 | Resistor, wire wound, 250 ohms, $\frac{1}{4}$ W, 1% | R18-6-250 |
| R128 | Resistor, deposited carbon, 20K, $\frac{1}{3}$ W, 1% | R12-20K |
| R129 | Resistor, composition carbon, 10K, $\frac{1}{2}$ W, 10% | R1-10K |
| R130 | Resistor, deposited carbon, 1 meg, $\frac{1}{3}$ W, 1% | R12-1M |
| R131 | Resistor, deposited carbon, 60K, $\frac{1}{3}$ W, 1% | R12-60K |
| R132 | Same as R130 | |
| R133 | Resistor, deposited carbon, 5 meg, 1W, 1% | R13-5M |
| R134 | Resistor, deposited carbon, 8 meg, 1W, 1% | R13-8M |
| R135 | Same as R123 | |
| R136 | Resistor, wire wound, 22.5K, $\frac{1}{2}$ W, 1% | R18-10-22.5K |

SPJ
10/74

104

REPLACEABLE PARTS LIST - MODEL 410

| Circuit Desig. | Description | Part No. |
|----------------|---|-------------|
| R137 | Potentiometer, wire wound, 5K, 2W, 20% | RP3-5K |
| R401 | Resistor, composition carbon, 100 ohms, $\frac{1}{2}$ W, 10% | R1-100 |
| R402 | Resistor, composition carbon, 470 ohms, $\frac{1}{2}$ W, 10% | R1-470 |
| R403 | Same as R401 | |
| R404 | Same as R402 | |
| R405 | Same as R401 | |
| R406 | Same as R401 | |
| R407 | Resistor, power, 10K, 5W, 3% | R4-10K |
| R408 | Resistor, composition carbon, 100K, $\frac{1}{2}$ W, 10% | R1-100K |
| SR1 | Rectifier, selenium, 65 ma., 130 V AC input | RF-17 |
| SR2,3,4,5,6 | Same as SR1 | |
| SW1 | Range switch, teflon insulated | SW-30 |
| SW2 | Input shorting switch, teflon insulated | - |
| SW3 | Meter Polarity, switch, DPDT toggle | SW-14 |
| SW4 | Power line switch, DPDT toggle | Same as SW3 |
| TI | Transformer regulating; Pri, 100-130v, 60 cps; Sec. 1, 600v dc. @ 20 ma, center tapped; Sec. 2, 250v dc. @ 50 ma, center tapped; Sec 3, 6.3v ac. @ 0.6A; Sec. 4, 6.3v ac. @ 0.6A; Sec. 5, 6.3v ac. @ 2.0A Furnished with C408, tuning capacitor | TR-17 |
| V1 | Electrometer tube, Raytheon CX 5886, matched with V2 | EV 5886-5 |
| V2 | Electrometer tube, Raytheon CK 5886, matched with V1 | EV 5886-6 |
| V3 | Vacuum tube, type 6CB6 | EV 6CB6 |
| V4 | Same as V3 | |
| V5 | Vacuum tube, type 6CM6 | EV 6CM6 |
| V6 | Vacuum tube, type OB2 | IV OB2 |
| V7 | Same as V6 | |

REPLACEABLE PARTS LIST - MODEL 410

| Circuit Desig. | Description | Part No. |
|---|--|----------|
| CONNECTORS ON CHASSIS | | |
| Input Connector | Connector, teflon insulated | CS-12 |
| Output Connector | Connector, two terminal | CS-18 |
| Chamber | Plus 216 volt connector for ion chamber | CS-16 |
| MATING PLUGS FURNISHED WITH INSTRUMENTS | | |
| Power Connector | Power cord receptacle | CP-1 |
| Power Plug and Cord | Six foot power cord with plug for outlet and socket to mate with power connector | CO-3 |
| Input Plug | Plug, teflon insulated | CS-13 |
| Output Plug | Plug, two terminal | CS-19 |
| Chamber Plug | Plug, $\frac{1}{4}$ " cable | CS-17 |

| REVISIONS | | | |
|-----------|--------|------|---------|
| LTB | ECO No | APPR | DATE |
| A | | | |
| B | 1425 | | 1-12-62 |
| C | 1720 | | 5-16-62 |
| D | 2100 | | 6-17-62 |
| E | 2221 | | 8-3-62 |
| F | 3001 | | 7-4-64 |

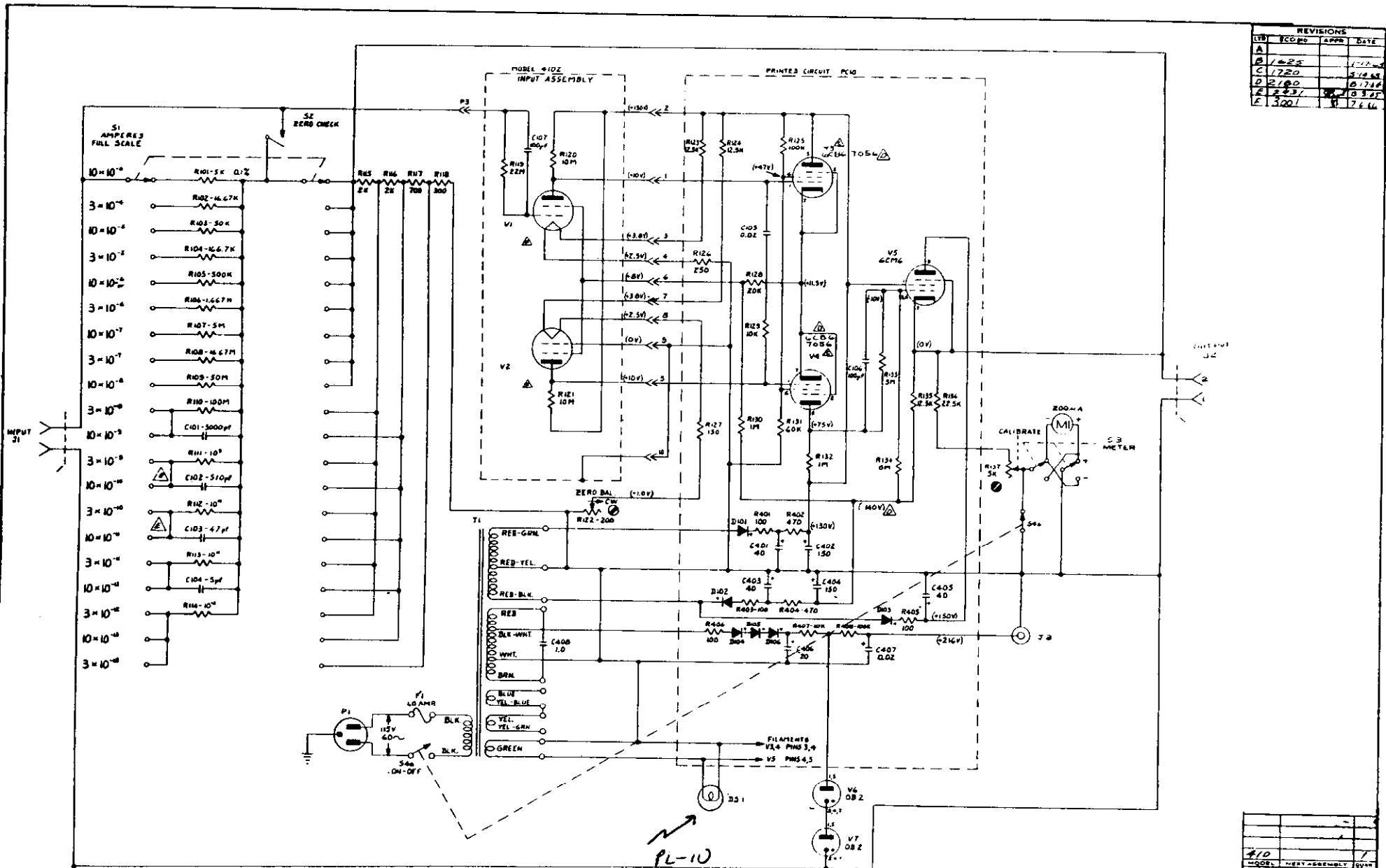

NOTES:
 1) VOLTAGES MARKED () MEASURED WITH OUTPUT ZEROED WITH 100MΩ INTERNAL RESISTANCE & CAPACITANCE SHALL BE DESIGNATED IN OHMS & MICROFARADS RESPECTIVELY UNLESS OTHERWISE NOTED
 2) FRONT PANEL CONTROL
 3) FRONT PANEL SCREWDRIVER ADJ. - C.W. ROTATION
 4) REAR PANEL SCREWDRIVER ADJ.
 5) INTERNAL SCREWDRIVER ADJ.
 6) NOMINAL VALUE ADJUSTED AT FACTORY
 7) 1000 OHMS
 8) MICROOHMS
 9) MICROFARADS

| | | | |
|---------------|--------------|---|---|
| DRW. R. R. | DATE 11/1/62 | KEITHLEY INSTRUMENTS CLEVELAND, OHIO | TITLE SCHEMATIC, MODEL 410 MICRO MICROAMMETER |
| CAD | DATE | | |
| ENG. | DATE | MATERIAL | PART NUMBER |
| PILOT RELEASE | DATE | FINISH | 10867D |
| PROD. RELEASE | DATE | | |

RANGE SWITCH ELEMENT

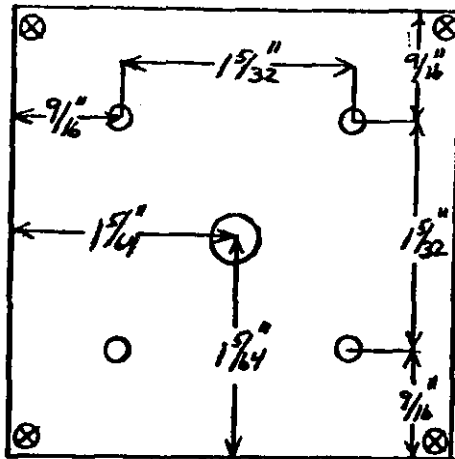

MOUNTING PLATES
FRONT VIEW

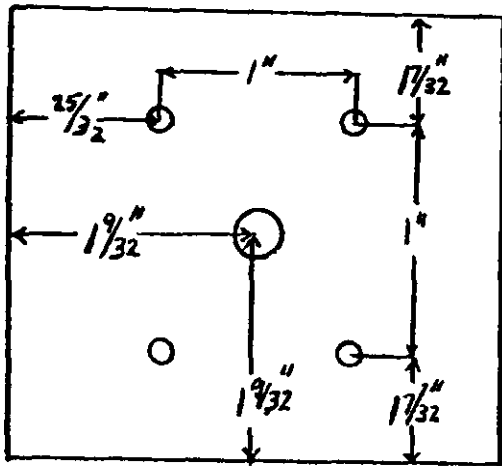

OLD SWITCH

FEED BACK

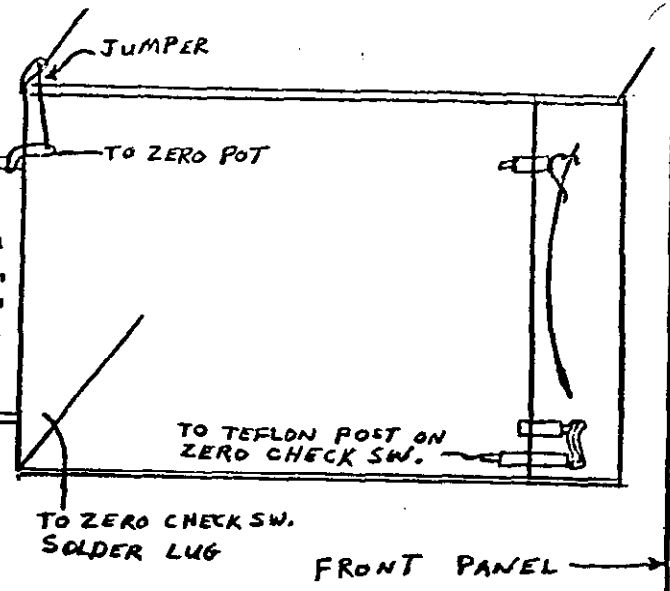

NEW SWITCH

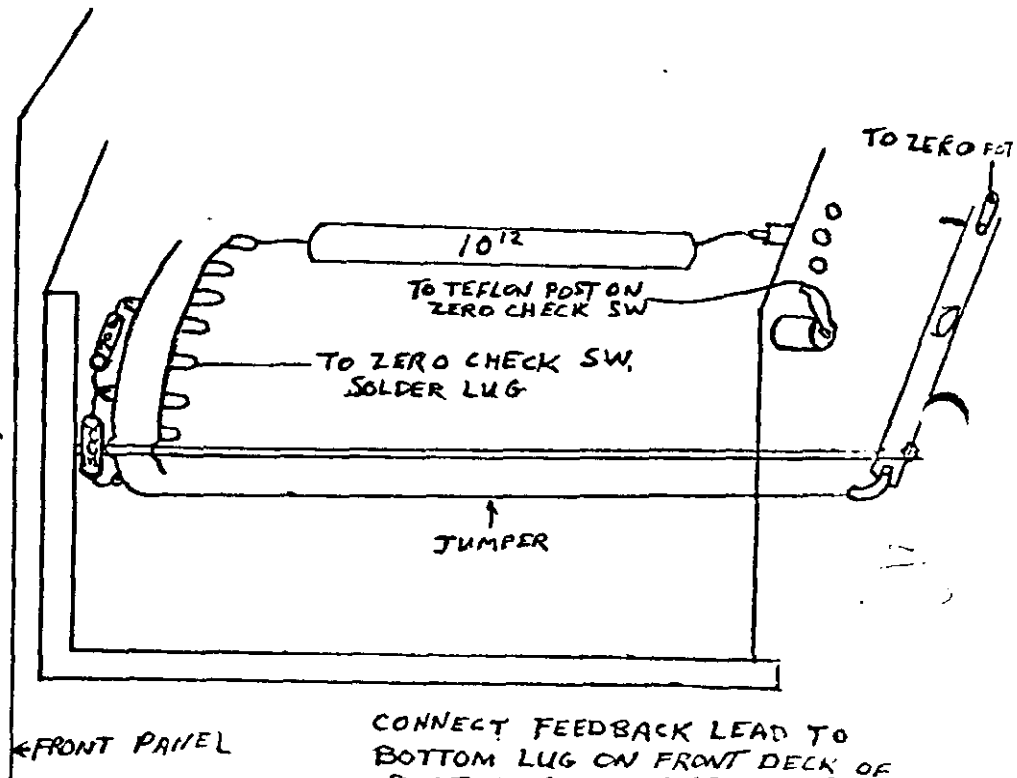

CONNECT FEEDBACK LEAD TO
BOTTOM LUG ON FRONT DECK OF
SWITCH OPPOSITE OF SIDE SHOWN.
A 2K RESISTOR (R115) IS ON THE
SAME LUG. REFER TO THE
SCHEMATIC FOR DETAILS.

DR 11844 C

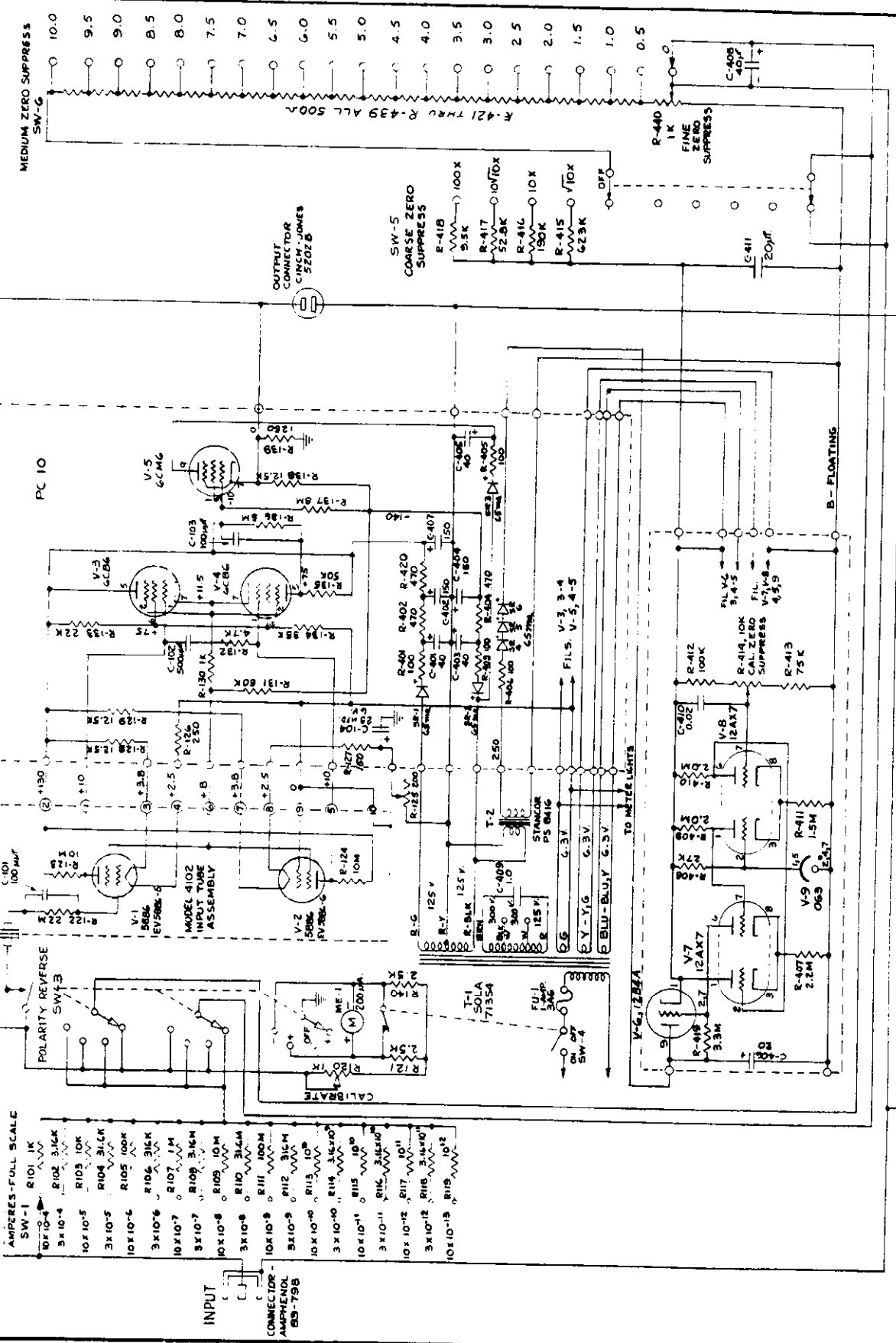

- AMPERES-FULL SCALE**
- SW-1 R101 1K
 - 10x10⁻⁴ R102 3.16K
 - 3x10⁻⁴ R103 10K
 - 10x10⁻⁵ R104 31.6K
 - 3x10⁻⁵ R105 100K
 - 10x10⁻⁶ R106 316K
 - 3x10⁻⁶ R107 1M
 - 10x10⁻⁷ R108 3.16M
 - 3x10⁻⁷ R109 10M
 - 10x10⁻⁸ R110 31.6M
 - 3x10⁻⁸ R111 100M
 - 10x10⁻⁹ R112 316K
 - 3x10⁻⁹ R113 1M
 - 10x10⁻¹⁰ R114 3.16x10⁴
 - 3x10⁻¹⁰ R115 10⁵
 - 10x10⁻¹¹ R116 3.16x10⁶
 - 3x10⁻¹¹ R117 10⁷
 - 10x10⁻¹² R118 3.16x10⁸
 - 3x10⁻¹² R119 10⁹
 - 10x10⁻¹³ R120 3.16x10¹⁰
 - 3x10⁻¹³ R121 10¹¹
 - 10x10⁻¹⁴ R122 3.16x10¹²
 - 3x10⁻¹⁴ R123 10¹³
 - 10x10⁻¹⁵ R124 3.16x10¹⁴
 - 3x10⁻¹⁵ R125 10¹⁵
- CONNECTOR - AMPHENOL 53-79B**

MODEL 410BL MICROAMMETER
 CIRCUIT SCHEMATIC DIAGRAM
 KEITHLEY INSTRUMENTS
 CLEVELAND, OHIO
 DATE 9/15/58
 SP
 DR 11844 C

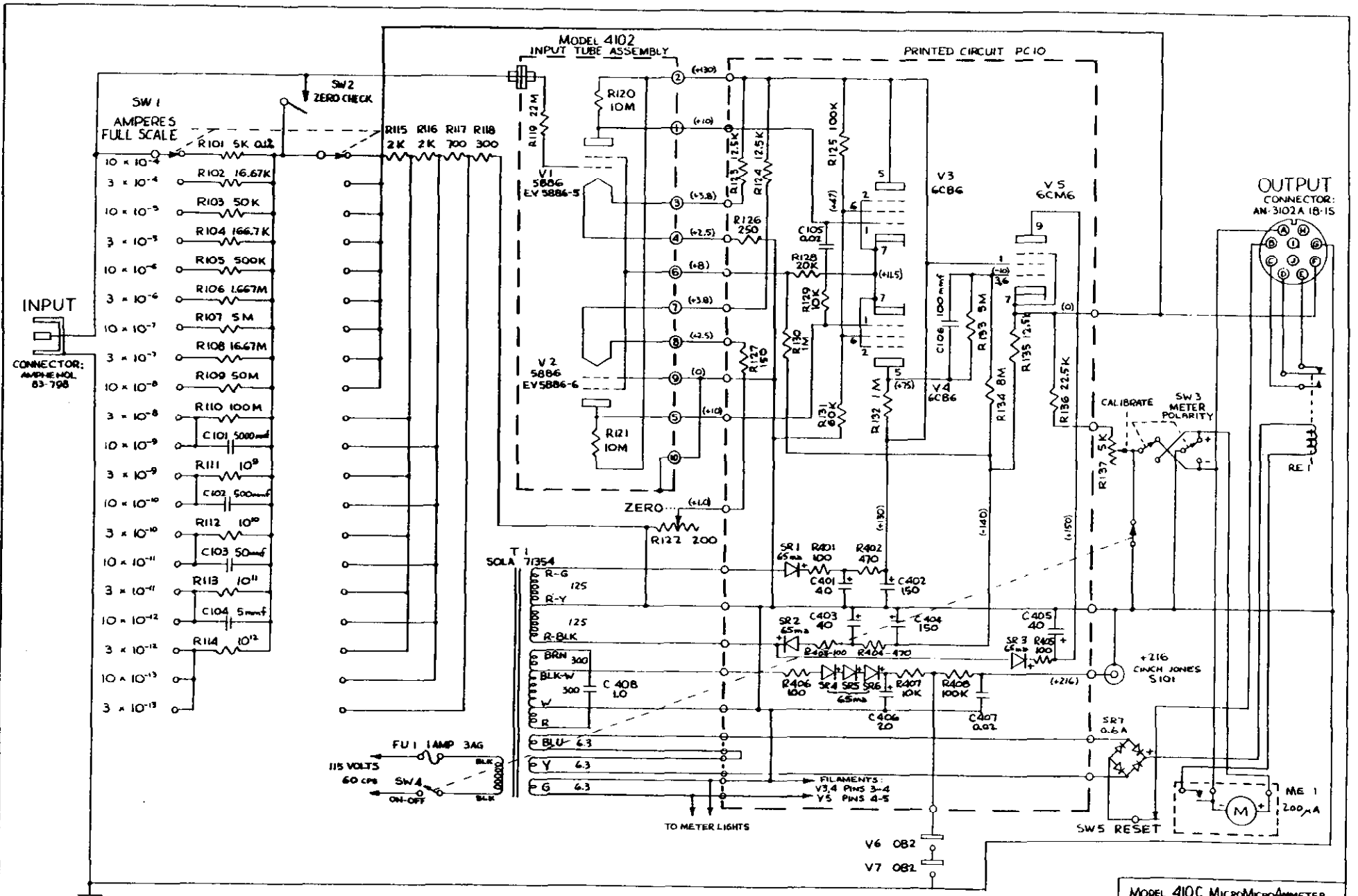

NOTE: VOLTAGES MARKED () MEASURED WITH OUTPUT ZEROED WITH VTVM.

MODEL 410C MICROMICROAMMETER
CIRCUIT SCHEMATIC DIAGRAM

KEITHLEY INSTRUMENTS
CLEVELAND, OHIO

WORK 23737 ISSUE 3 DR 11165 - C

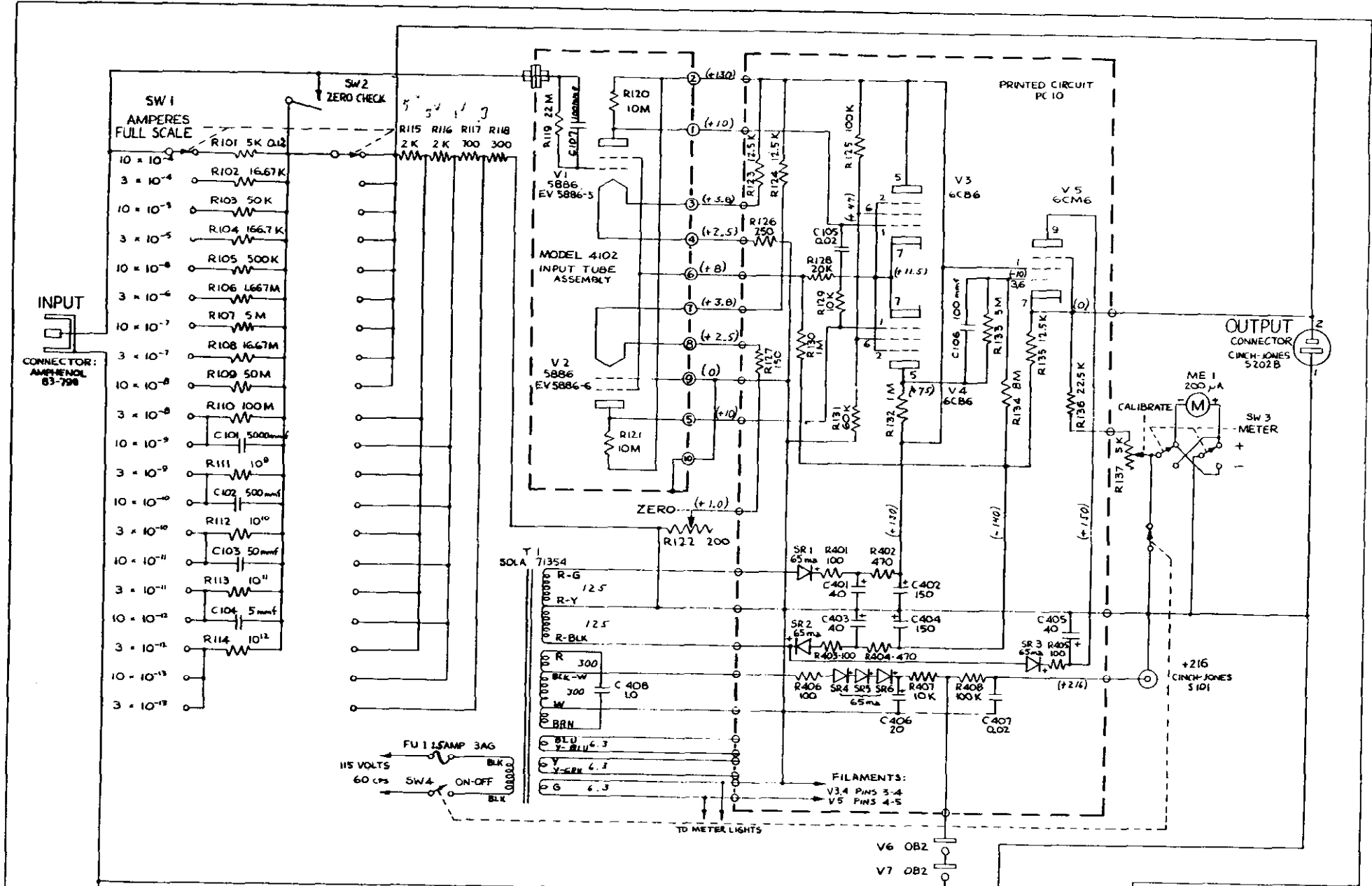

MODEL 410 MICROMICROAMMETER
CIRCUIT SCHEMATIC DIAGRAM

KEITHLEY INSTRUMENTS
CLEVELAND, OHIO

WEEK 3-2257 ISSUE 8 DR 10867 C